

AFA ultraCUBE Water Management System

USER MANUAL

A system developed for maintaining bath water quality in Covaris AFA™ instrumentation

Product Name: AFA ultraCUBE

Product Number: 500577



UNIVERSAL PRECAUTIONS

Universal Precautions should be followed on all specimen samples, regardless of whether a sample is known to contain an infectious agent. Laboratories handling specimen samples are advised to comply with applicable parts of the following governmental and clinical standards, or their equivalent in the country of use:

- Centers for Disease Control (CDC), Universal Precautions for Prevention of Transmission of HIV and Other Bloodborne Infections, published 1987, updated 1996
- Clinical and Laboratory Standards Institute (CLSI), GP17-A3 Clinical Laboratory Safety; Approved Guideline - Third Edition, published 2012, ISBN 1-56238-797-9
- Clinical and Laboratory Standards Institute (CLSI), M29-A4 Protection of Laboratory Workers from Occupationally Acquired Infections; Approved Guideline, Fourth Edition, published 2014, ISBN 1-56238-961-0
- Occupational Safety and Health Administration (OSHA), 29 CFR 1910.1030 Bloodborne Pathogens
- International Standards Organization (ISO) 15190:2003, Medical Laboratories – Requirements for Safety

Trademarks

Patented or patent pending and registered or registration-pending trademarks of Covaris are protected. Registered names and trademarks used in this document, even when not specifically marked as such, are not to be considered unprotected by law.

WCS 2.0 and AFA are either registered trademarks or trademarks of Covaris, Inc. in the United States and/or other countries.

Information subject to change without notice

For Research Use Only

Not for use in diagnostic procedures

Publication P/N 010393 Rev C

June 2018

Products covered by Patent No. US6, 719,449, US6, 948,843, and other pending applications

Copyright ©2017 Covaris, all rights reserved.

Covaris, Incorporated
14 Gill St, Unit H
Woburn, Massachusetts
01801-1721 USA

Printed in U.S.A.

Warranty

When used in accordance with written instruction and under normal operating conditions, the Covaris instruments are guaranteed to be free of defects in MATERIAL and WORKMANSHIP for one (1) year from the date of original delivery. Any component which proves defective during the stated period will be repaired free of charge or replaced at the sole discretion of Covaris, F.O.B., Woburn, Massachusetts, provided the defective component is returned properly packaged with all transportation charges prepaid. The customer is expected to perform basic diagnostics and component replacement with telephone support from Covaris personnel. If Covaris personnel are required to perform on-site repair, all travel costs are paid by the customer. A limited warranty as specified may apply to certain components of the equipment.

Warranty Exceptions

This warranty is void if failure of the software or hardware has resulted from accidents, abuse, improper maintenance, or repair, or misapplication by the customer. It is also void if damage is caused by any unauthorized attachments or if modifications are made to the equipment. Removing or tampering with the Safety Enclosure will void the warranty, and the customer will assume all liabilities.

This warranty is limited to the original purchaser and is not transferable.

CONTACT COVARIS, INC. SHOULD YOU HAVE ANY QUESTIONS CONCERNING THIS EQUIPMENT.

Warranty Services

The purchased equipment is covered by a twelve (12) month warranty which includes all the service and support necessary so that the customer can operate the equipment successfully. Extended warranties are available at the end of the original 12 month warranty period.

Services included with the original purchase of the system are:

Installation and Training – Setup and installation of the equipment and operator training can be purchased at time of initial acquisition of the equipment. Both will be performed by a qualified Covaris service representative. One half day will be scheduled to perform the installation and on-site training.

- The operators' training will include valuable hands-on time with the equipment.
- Preventative maintenance and troubleshooting tips will also be covered.

Technical Support – On-going assistance with the operation or application of the equipment and/or troubleshooting is provided via:

- Telephone
 - United States: Tel: +1 781 932 3959 during the hours of 9:00am to 5:00pm, Monday through Friday, Eastern Standard Time (EST), Greenwich Mean Time (GMT-05:00)
 - Europe: Tel: 44 (0) 845 872 0100, during the hours of 9:00am to 5:00pm, Monday through Friday, Greenwich Mean Time
- E-mail queries to techsupport@covarisinc.com or applicationsupport@covarisinc.com

Parts Replacement – Replacement of parts (excluding consumables) for normal operation of equipment are provided on a priority basis. Shipping charges are included. Failure due to accident, abuse, or improper operation is not covered.

This page intentionally left blank.

TABLE OF CONTENTS

1.0	INTRODUCTION	6
2.0	ultraCUBE Installation and Setup	10
3.0	Indicators and Controls	12
4.0	System Operation	14
5.0	Specifications	15
6.0	Service	16
	Appendix B – User Guidelines and Troubleshooting.....	23
	Appendix C – Bio-safety References.....	23

1.0 INTRODUCTION

1.1 Overview of the Manual

This manual contains operation and service instructions for the *Covaris ultraCUBE Water Management System*. It contains background information essential to the proper use and care of this equipment.

Should any unforeseen problems occur with the normal operation of the equipment, contact Covaris Technical Support immediately.

The following definitions apply in this manual:

NOTE: Inconvenience if disregarded.

CAUTION: Equipment damage may occur.

WARNING: Personal injury may occur.

1.2 Safety Symbols and Warnings

The following symbols are employed in product labeling and in this manual. Where these relate to safety risks, failure to observe the associated precautions could result in injury to people or damage to property.



This is the general alert symbol. It may be used to alert you to potential safety hazards. Obey all safety messages that follow this symbol.



This symbol is used to identify an ELECTRICAL SHOCK hazard.



This symbol is used to identify an ULTRAVIOLET LIGHT hazard.



This symbol is used to identify a potential BIOLOGICAL hazard.

1.3 For the safety of operating personnel

1. Make sure that the power supply module is properly grounded. Employ a power cable with a grounding prong, plugged to a power receptacle with a grounded receptacle. DO NOT operate the unit if it is not properly grounded.
2. The unit is equipped with a power plug appropriate for the destination country. DO NOT, under any circumstances, remove the grounding prong from the power cord.
3. Always disconnect power to the equipment (unplug) before performing any service or maintenance. Reconnect power only as instructed.
4. Employ only the 12 volt DC power module provided with the unit, or a replacement provided by Covaris.
5. Follow all precautions when changing the UV lamp. Avoid exposure to direct or strongly reflected germicidal ultraviolet rays. Germicidal ultraviolet rays are harmful to the eyes and skin.
6. THE ULTRAVIOLET LAMP CONTAINS MERCURY (Hg). Handle carefully to avoid breaking the lamp. Dispose of used lamps according to disposal laws. For further information, see one of the following websites or contact Covaris.
www.lamprecycle.org (North America)
www.lamprecycling.com (North America)
www.mercuryrecycling.co.uk (UK)
www.malampe.org (France)
7. If there is a safety related malfunction, DO NOT operate the equipment and contact Covaris immediately.
8. If the equipment is used in a manner not specified by the manufacturer, the protection provided by the equipment may be impaired. Do not remove safety labeling.

1.4 To prevent damage to the equipment:

1. The AFA ultraCUBE system is designed for indoor use and to operate in typical ambient laboratory conditions e.g., 19°C to 25°C (66°F to 77°C). DO NOT operate the instrument in a cold room environment. The system is designed to operate with a water bath and recirculating heater/chiller apparatus to control sample temperature.
2. The AFA ultraCUBE system is designed for use with chilled or room temperature bath water. Condensation, however, may form on interior surfaces and drip onto the bench top when the instrument bath water is chilled.
3. Distilled or de-ionized water should be used to fill the water bath.
4. Do not employ isopropyl alcohol, ammonia-based or abrasive cleaners on the water tank, as these will damage the acrylic surfaces.
5. When cleaning the Ultrasonicator system using bleach or an equivalent solution, turn off and disconnect the hoses to the AFA ultraCUBE system.
6. The WCS 2.0 requires periodic filter and UV lamp replacement, as described in this manual.
7. Do not directly handle the UV lamp – only handle it while wearing cotton or laboratory gloves to avoid fingerprints on the lamp glass.

1.5 Acronyms employed in this User Manual

WCS 2.0 – Water Conditioning System version 2
UV – Ultraviolet
AFA™ – Adaptive Focused Acoustics

1.6 Product Description

Overview

The AFA ultraCUBE is Covaris' most advanced water management solution for the Covaris line of Focused-ultrasonicators. It combines a high performance solid state CH05 chiller with the Covaris WCS 2.0 water conditioning system, consisting of a UV lamp for controlling biological growth with a 5 micron particulate filter.

When used in conjunction with ultraCUBE enabled software, the ultraCUBE will automatically switch between chilling/heating mode and standby mode, in which water continues to circulate through the WCS to maintain water quality without the energy consumption required for cooling.

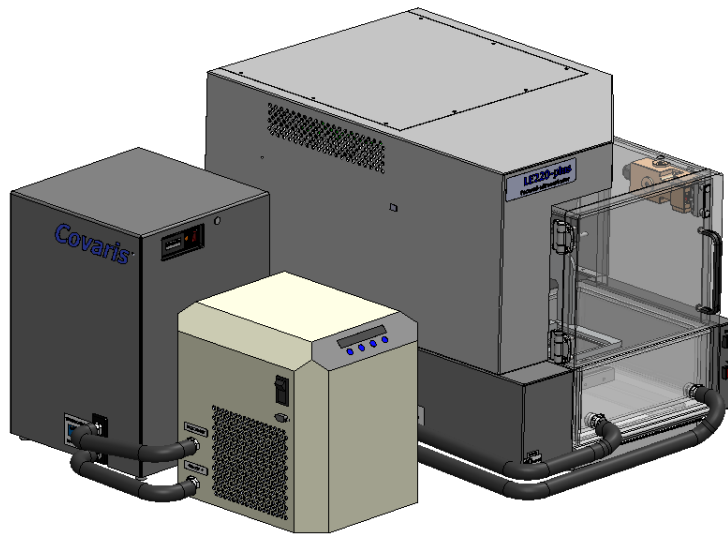

System Components

The CH05 chiller is the ThermoCube 400 modified specifically for Covaris. This chiller provides approximately 200 watts of cooling capacity at 10° C, cooling the bath water directly, with no need for a heat exchanger in the instrument bath, or for antifreeze solution in the chiller.



The Water Conditioning System (WCS 2.0) is Covaris' second generation water cleaning system, incorporating a simpler design, but keeping the same particulate filtering capability

and ultraviolet lamp as our proven earlier design. The particulate filter is rated for 5 micron, so will catch most particulates and many cell types.

The Covaris CH05 chiller and WCS 2.0 operate in combination to circulate the instrument's bath water through the WCS 2.0 ultraviolet (UV) sterilizer and particulate filter to ensure that the water remains clean and free of algae growth for up to one month. The system is designed to run continuously, maintaining water quality and relieving the need for daily water changes in Covaris Adaptive Focused Acoustics (AFA™) systems.



Figure 1 – The Covaris Water Conditioning System

The WCS 2.0 incorporates an elapsed hours timer and maintenance due indicator for filter and UV lamp replacement after one year of use. Filter and UV lamp replacement may be performed by the user by following instructions included in this manual.

The system's power is supplied by a small external converter that operates with any worldwide AC power source (100 to 240 volts AC) and connects to a power jack on the rear panel of the WCS 2.0.

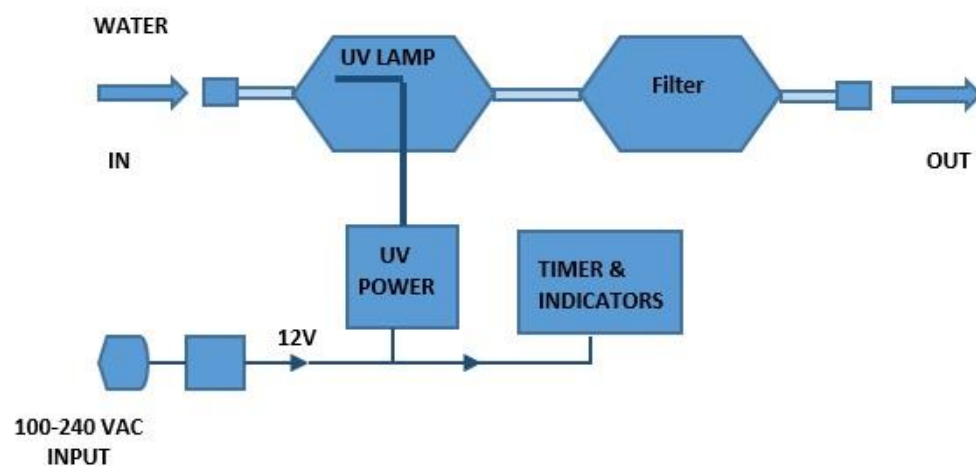

Water Conditioning System block diagram

2.0 AFA ultraCUBE Installation and Setup

Unpacking:

- Remove the CH05 from its box and remove the foam packaging.
- Remove the WCS 2.0 accessories and cardboard accessory tray from the WCS 2.0 box.
- Pull the WCS 2.0 unit out of the box and remove side foam packaging.

The WCS 2.0 box should contain the following items:

- This User's Manual
- The WCS 2.0 unit
- 12 volt "universal" input power supply module
- AC power line cord
- UV lamp (packaged separately in a cardboard tube to avoid shipping damage)
- Quartz tube for UV chamber (packaged separately to avoid shipping damage)
- One pair of laboratory gloves
- Water hoses to interconnect the CH05, WCS 2.0, and the Ultrasonicator

The CH05 box should contain:

- The CH05 Chiller
- RS232 Interface cable for controlling the CH05 from the LE220-plus
- AC power line cord
- The ThermoCube document package, including the ThermoCube manual on CD.

Setup:

- Refer to **Appendix A** of this manual to install the quartz tube and UV lamp into the WCS 2.0.
- Place the WCS 2.0 and the CH05 on the bench next to the Ultrasonicator. They may be placed on either side, or on the floor to save bench space as long as the hoses reach from the front of the Ultrasonicator to the WCS 2.0.
- Connect the hoses between the WCS 2.0 and the CH05, using the two short hoses, as shown below.
- Connect the two longer hoses from the Ultrasonicator bath to the remaining ports on the WCS 2.0 labeled "Water Tank". Either bath port can connect to either of the Water Tank WCS 2.0 ports. Make certain that sufficient air flow is available for cooling the CH05.

Note: Previous Covaris products used low pressure black neoprene hose. Because the pump in the CH05 chiller can generate more pressure than the black hose can tolerate, the ultraCUBE comes with a white, high pressure hose. Failure to use the correct hose can result in the hose failing and emptying the LE220-plus water bath. See figure below to identify the correct hose type.

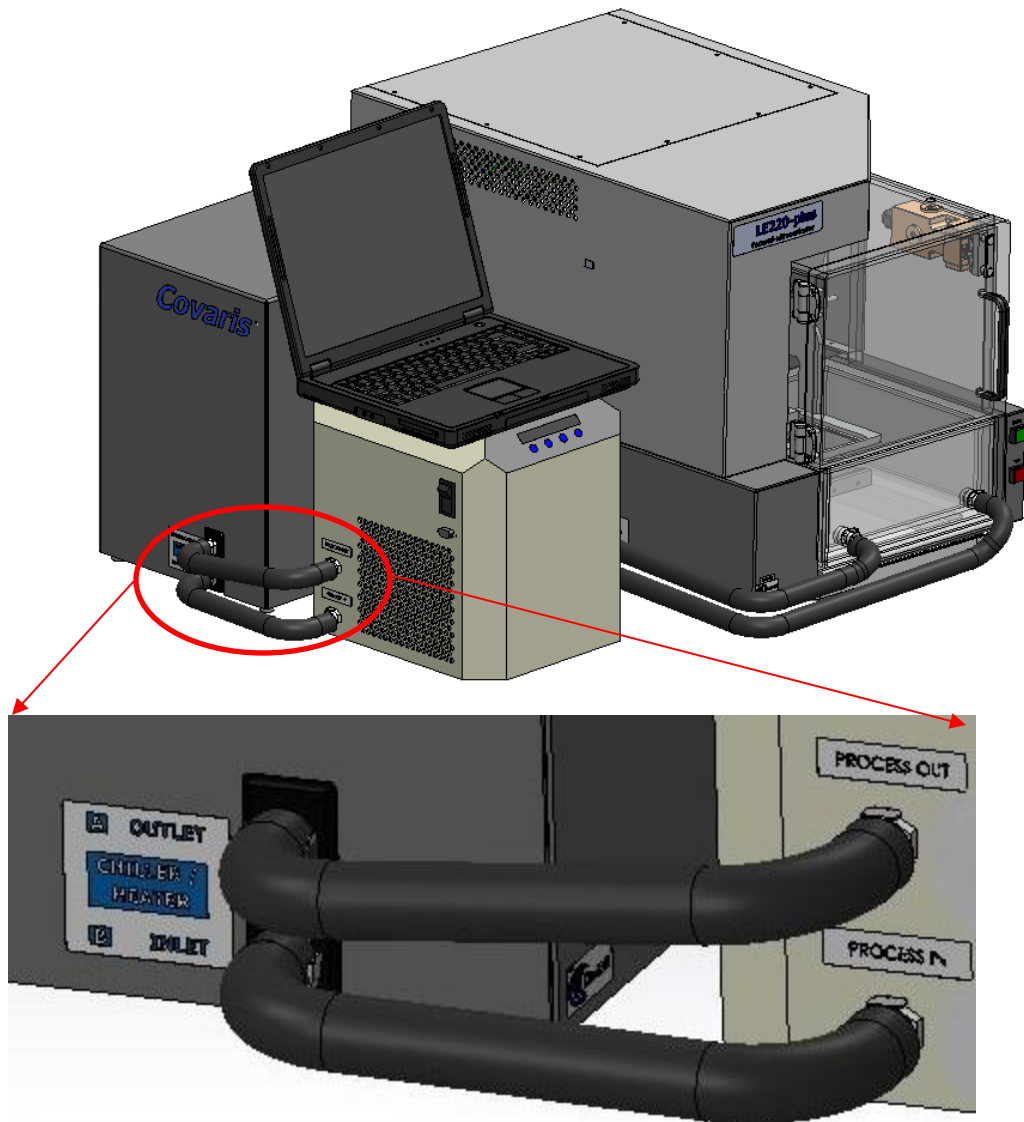

- Connect the RS232 interface cable between the D-connector port, located below the power switch of the CH05, and the matching connector on the rear panel of the LE220-plus.

RS232 Communications Port

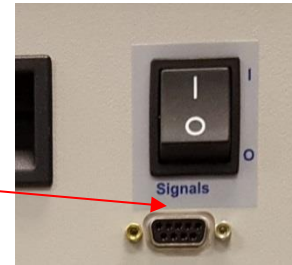

- With the WCS 2.0 ON/OFF switch in the OFF position, connect the power supply to the 12V socket on the rear panel of the WCS 2.0 unit. Connect the power supply to AC power (100 to 240 volts AC, 50 or 60 Hz).
- Connect the line cord to the CH05 and connect the cord to AC power (115 to 240 volts AC, 50 or 60 Hz).

NOTE: The WCS 2.0 unit is shipped with the UV chamber quartz tube and UV lamp not installed. Install these items before powering the unit or using it in any way. See Appendix A for UV lamp and quartz tube installation and replacement instructions.

CAUTION: The ultraCUBE is designed to operate with hoses connected to a filled water tank as depicted in the following illustrations. Avoid running the ultraCUBE 2.0 either dry or disconnected from a source of water.

3.0 Indicators and Controls

There are four operating status indicators on the front panel of the WCS 2.0, as shown.

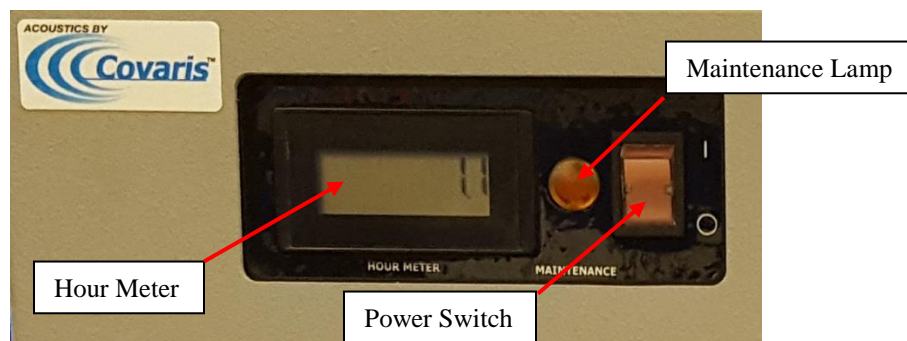

Detail of the WCS 2.0 Status Indicators

These indicators operate as described below:

- **POWER SWITCH** – When the system is powered ON, the Power switch is illuminated.
- **HOUR METER** – This display shows total elapsed hours of operation in hours and tenths of an hour. When the counter reaches any multiple of 9500.0 hours (approximately 13 months), the MAINTENANCE indicator will illuminate and a CHG lamp icon will appear on the display, indicating that the internal particulate filter and UV lamp should be replaced within 500 hours of additional operation.

Please note that a new WCS 2.0 will have a small number of hours elapsed as part of its initial testing.

- **MAINTENANCE** – When illuminated, this indicates that the UV lamp and particulate filter should be replaced. The WCS 2.0 will continue to operate effectively for up to 500 hours after the indicator illuminates, but it is recommended that the UV lamp and filter be replaced as soon as is practical after the MAINTENANCE indicator illuminates. The indicator is shut off by pressing an internal RESET button once replacement is performed. Please see Appendix A for UV lamp and filter replacement instructions. *This indicator will also illuminate if the UV lamp is missing or damaged.*

NOTE: The hour meter displays to 0.1 hour resolution. 500 hours will appear as 500.0 and 5000 hours will appear as 5000.0.

There are four buttons and a graphic display on the CH05 chiller.

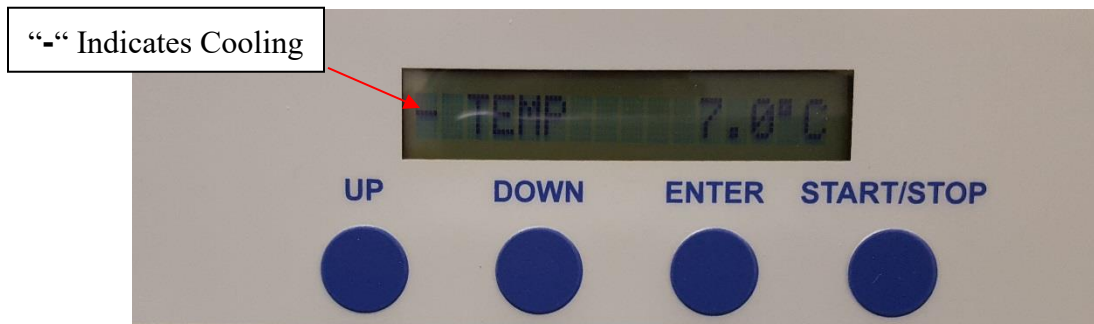

Pressing the “UP” button raises the displayed temperature set point value.

Pressing the “DOWN” button lowers the displayed temperature set point value.’

Pressing the “ENTER” button sets the temperature set point to the displayed value and returns the display to indicating actual water temperature.

Pressing the “START/STOP” button toggles the CH05 between cooling (or heating) and standby mode. Cooling is indicated by a “-“ at the left of the graphic display; heating is indicated by a “+“; and standby is indicated by an “*“ . When in Standby mode, the CH05 continues to pump bath water through the WCS 2.0, but the heating/cooling element is inactive.

Note: the asterisk, “*”, indicating Standby mode, is very similar to the “snowflake” icon used by many chillers to indicate that the refrigeration unit is active. On the CH05, the “*” indicates that the cooling/heating element is inactive.

4.0 System Operation

NOTE: The ultraCUBE is designed to operate continuously, except when water is being changed in the AFA system water tank.

Fill the Covaris system water bath tank with distilled or de-ionized water. Approximately one liter of water will be drawn into the WCS 2.0 upon first use, so keep extra water on hand.

The first time the ultraCUBE is used, air will be purged from the filter and UV chamber of the WCS 2.0 as water is drawn from the Ultrasonicator bath. This initial air purging creates turbulence in the Ultrasonicator bath, which may cause some bath water to spill over the top of the bath. For this reason, the bath should initially be filled only half full the first time the ultraCUBE is operated.

Turn the WCS 2.0 and CH05 ON/OFF switches to the ON position. The WCS 2.0 switch will illuminate, the hour meter will start and the CH05 pump will start to draw water from the water bath. Bubbles will briefly appear in the Ultrasonicator bath as air is purged from the WCS 2.0 system. Once the air is fully purged from the WCS 2.0, add distilled or de-ionized water to the bath tank to restore the water level in the bath.

Note: when the air is purged from the WCS 2.0, the bubbling in the water bath creates noticeable turbulence. This is normal and the turbulence subsides once the WCS 2.0 fills with water.

The CH05 and WCS 2.0 system, when operating, will automatically circulate bath water, filter it and retard the growth of algae or bacteria by irradiation with UV light. It is recommended that both be run continuously for longest UV lamp life and best cleansing effect upon bath water. The CH05 should be placed in standby mode to continue pump operation without cooling when the instrument is not in use. Press and release the “START/STOP” button until the “*” is displayed at the far left of the CH05 display to place the CH05 in standby.

When employing the WCS 2.0 with a Covaris water bath, users may refrain from changing bath water for up to one month. Please note that evaporation will occur, so the bath water level should be verified daily and distilled or de-ionized water added to the bath as needed.

If the WCS 2.0 is employed with chilled bath water, condensation may form on internal fittings and hoses, causing some water to drip onto the laboratory bench beneath the WCS 2.0. This condensation is normal and should abate when the bath water is not chilled. The WCS 2.0 may be placed on an absorbing mat to contain this condensation.

Water dripping from the WCS 2.0 when it is not powered or when employed with room temperature bath water may indicate a leak. The cover may be opened and the fittings examined to determine the source. (See Appendix A for instructions on opening and closing the WCS 2.0. See Appendix B for troubleshooting instructions).

Please note that the ultraCUBE will only chill, filter, and treat the bath water with disinfecting UV radiation. The WCS 2.0 **does not** make up for evaporated water or degas the water.

Cleaning

The outside surfaces and switch panel can be cleaned with a water-dampened cloth and mild detergent.

NOTE: When cleaning the AFA System with a bleach or equivalent solution, turn the CH05 chiller and WCS 2.0 OFF and disconnect the circulating hoses from the water bath. The filter and fittings of the WCS 2.0 are not compatible with dilute bleach.

Submersion or excess liquid in the electronics cabinet may harm the electronics and subsequent problems will not be covered under warranty. Do not use abrasives or solvents.

5.0 Specifications

Model	WCS 2.0	CH05
Power Input	100 – 240 VAC, 50-60 Hz, 1.0 A	115-230 VAC, 50/60 Hz, 7.5 A
Dimensions	28 cm (11 inches) deep, 28 cm (11 inches) wide and 41 cm (16 inches) high.	33 cm (13 inches) deep, 28 cm (11 inches) wide and 33 cm (13 inches) high.
Weight	Approximately 4.5 kilograms (10 lbs)	Approximately 12.7 kilograms (28 lbs)
Ambient Temp.	19°C to 25°C (66°F to 77°C)	0°C to 40°C (32°F to 104°F)
Ambient Hum.	30% to 70%	Non-condensing
Safety	Certified compliant to Low Voltage Directive 2006/95/EC, EN/UL/CSA 61010-1 “Safety Requirements for Electrical Equipment for Measurement, Control and Laboratory Use, Part 1: General Requirements	Low Voltage Directive Safety requirements for electrical equipment for measurement, control, and laboratory use EN 61010-1: 3 rd Edition
EMC	Complies with emissions and immunity standards per EMC Directive 2004/108/EC, EN 61236-1, FCC Part 15, and ICES-003 for Class A equipment.	EMC Directive 2004/108/EC Low Voltage Directive 2006/95/EC Emissions & Immunity EN 61326-1: 2006 Harmonics Emissions EN 61000-3-2: 2006 Voltage Fluctuations & Flicker EN 61000-3-3: 2008



6.0 Service

The UV lamp and particulate filter are designed for replacement by the user following a MAINTENANCE indication on the WCS 2.0 front panel.

There are no other user-serviceable repairs. Please contact Covaris or your local Covaris representative for assistance.

Please direct any queries to:

- Telephone
 - United States: Tel: +1 781 932 3959 during the hours of 9:00am to 5:00pm, Monday through Friday, Eastern Standard Time (EST), Greenwich Mean Time (GMT-05:00)
 - Europe: Tel: 44 (0) 845 872 0100, during the hours of 9:00am to 5:00pm, Monday through Friday, Greenwich Mean Time
- E-mail queries to techsupport@covarisinc.com or applicationsupport@covarisinc.com

To place orders: CustomerService@covarisinc.com

CAUTION - PREPARING THE WCS 2.0 FOR SHIPMENT:

PURGE THE WCS 2.0 OF WATER AND REMOVE THE UV LAMP & QUARTZ TUBE

Please purge the WCS 2.0 of standing water prior to return shipment, particularly in cold weather, to prevent freezing damage.

To purge water from the system, connect the hoses to an *empty* water bath. Place the CH05 in standby to briefly pump water from the WCS 2.0 into the empty water bath.

Remove the UV lamp and quartz tube from the UV chamber. These are fragile and may break if shipped inside the WCS 2.0. If returning the lamp and tube with the WCS 2.0, please package these separately, ideally in its original shipping tubes, or inside a stiff tube or box with adequate packing material to prevent impact and breakage

See Appendix A for instructions on removing the UV lamp and quartz tube.

Invert the WCS 2.0 and pour any remaining water through the opening in the top of the UV chamber.

Appendix A – Periodic Maintenance

The WCS 2.0 incorporates an elapsed operating hour meter. When this meter reached 9500 (approximately 13 months of elapsed operation), the MAINTENANCE indicator will illuminate. The WCS 2.0 will continue to operate effectively for up to 500 hours following this indication, but it is recommended that the UV lamp and filter be replaced as soon as is practical after the MAINTENANCE indicator illuminates. Once these items have been replaced, the maintenance alert should be reset using an internal RESET button.

Replacement accessories are available from Covaris using the following part numbers:

- 500175 - Replacement Water Filter
- 500176 - Replacement UV lamp
- 500171 – E Series tank with Quick Connect fittings for use with the WCS 2.0
- 500575 – LE-Series CH05 Hose Repair Kit
- 500576 – LE-Series WCS 2.0 Hose Repair Kit

Quartz Tube Installation or Replacement

The Ultraviolet (UV) chamber consists of the outer chamber in which a quartz tube is suspended. The UV lamp is, in turn, suspended inside the quartz tube. Water circulated through the UV chamber outside the quartz tube is exposed to UV light radiating through the tube. To prevent breakage, the UV lamp and quartz tube are not installed in the UV chamber during shipment.



WARNING: Disconnect power to the WCS 2.0 before changing the UV lamp or quartz tube and follow the lamp replacement instructions. Exposure to UV light is hazardous to exposed skin and eyesight.

1. Turn the WCS 2.0 power OFF and disconnect the 12V power pack from the rear panel of the WCS 2.0 unit. Disconnect the two circulation hoses from the side of the WCS 2.0.
2. Remove the 6 screws securing the cover at the rear of the WCS 2.0 and the 3 screws securing the cover at the front of the WCS 2.0.

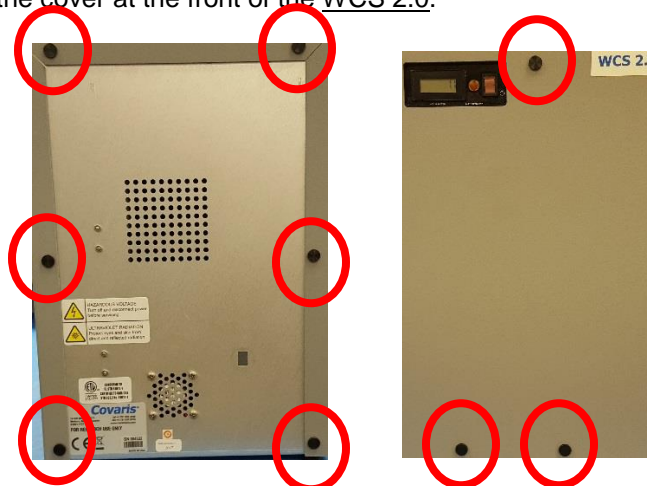

3. Carefully remove the outside cover of the WCS 2.0 by pulling it up and off the WCS 2.0 chassis.
4. If present, remove the UV lamp. See instructions below.
5. Remove the white cap at the top of the UV chamber by turning it counter-clockwise.

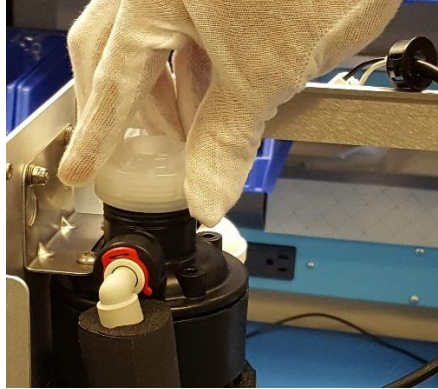

6. If a quartz tube is present, grasp the top of the tube and draw it out of the UV chamber by gently pulling upward. There are two O-rings which will likely come out with the tube. If the quartz tube is being installed for the first time, the two O-rings will be just below the white cap. Reach one finger into the chamber and lift out the two O-rings.
7. With the two O-rings positioned about a half-inch from the top of the quartz tube, slide the tube into the UV chamber.

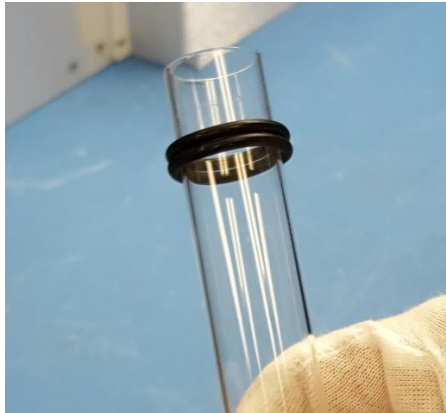

8. Thread the white cap onto the chamber by turning clockwise until snug. Hand tighten only.
9. Reinstall UV lamp.

Ultraviolet (UV) Lamp Installation or Replacement



WARNING: Disconnect power to the WCS 2.0 before changing the UV lamp and follow the lamp replacement instructions. Exposure to UV light is hazardous to exposed skin and eyesight.

1. Turn the WCS 2.0 power OFF and disconnect the 12V power pack from the side panel of the WCS 2.0 unit. Disconnect the two circulation hoses from the front of the WCS 2.0.
2. Remove the 6 screws securing the cover at the rear of the WCS 2.0 and the 3 screws securing the cover at the front of the WCS 2.0.
3. Carefully remove the outside cover of the WCS 2.0 by pulling it up and off the WCS 2.0 chassis.
4. Identify the UV lamp enclosure mounted on the rear wall of the WCS 2.0, next to the water filter.



UV Lamp Enclosure, Cap, and Cable

5. Gently pull on the cable to withdraw the lamp socket from the enclosure. If a lamp is already installed in the enclosure, it will be drawn out with the socket. If present, withdraw the lamp completely from the enclosure, then gently disconnect the socket from the lamp. THE ULTRAVIOLET LAMP CONTAINS MERCURY (Hg). Handle carefully to avoid breaking the lamp. Dispose of used lamps according to disposal laws. For further information, see one of the following websites or contact Covaris.

www.lamprecycle.org (North America)

www.lamprecycling.com (North America)

www.mercuryrecycling.co.uk (UK)

www.malampe.org (France)

6. While wearing cotton or laboratory gloves (to avoid getting fingerprints on the UV lamp glass), open the round cardboard cylinder (marked LAMP), carefully remove the glass UV tube and packing material.
7. Plug the UV tube into the lamp socket (The orientation of the bulb is not important).

- Slide the UV tube into the lamp housing and cover the hole with the provided black grommet.

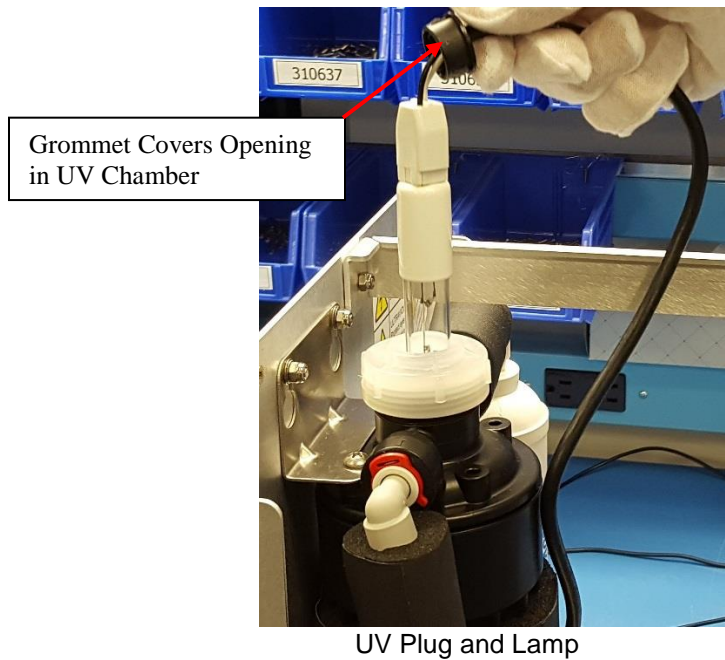

Particulate Filter Replacement



WARNING: If the Covaris system has been employed for processing of infectious or hazardous biological samples, laboratory gloves should be worn and the used filter cartridge treated as biohazard waste, in case any biological sample accidentally entered the bath and was captured by the filter system.

WARNING: Disconnect the WCS 2.0 from power and disconnect the two circulation hoses from the front of the unit before changing the lamp or filter.

1. Note the orientation of the tubes and filter cartridge on the back wall of the open WCS 2.0 cabinet, next to the UV chamber. The flow arrows should point towards the bottom of the WCS 2.0 cabinet.

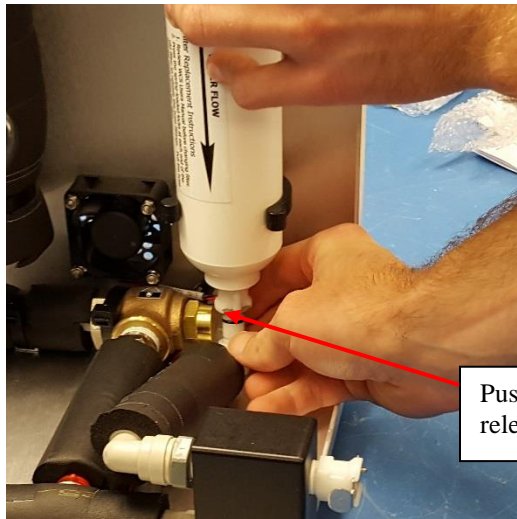

Push tab to release the fitting.

2. Position a paper towel under the lower Quick Connect fitting on the filter cartridge. Push the locking tab sideways to release the fitting. Repeat for the upper fitting. The quick release fittings will seal and prevent water from draining from the cartridge or tubing.

3. Pull on the used filter cartridge to remove it from the plastic grips.



4. Install the replacement filter by pressing it down into the plastic grips, taking care that the flow arrows point towards the bottom of the WCS 2.0 cabinet. Reconnect the fittings as originally found by pressing them into each Quick Connect socket until they snap securely.

WARNING: Moderate pinch hazard - Do not place your fingers under the filter cartridge near the retaining clips while pressing the cartridge into place.

Inspect and Prepare the WCS 2.0 for Use

5. With the WCS 2.0 cover off, verify that the UV lamp enclosure is fully closed (the black grommet covers the opening and the UV lamp is not visible). Fill the Covaris bath with distilled or de-ionized water, and reconnect the 12V power module. Turn ON the WCS 2.0 and CH05.
6. Verify that bubbles briefly appear in the bath as air is purged from the WCS 2.0 filter. Inspect fittings to ensure there are no water leaks.
7. Once the system is verified to be operating correctly, press and hold the RESET button located on the side of the electronics enclosure for about 5 seconds. This action turns the MAINTENANCE indicator off. (It will turn on again at the next multiple of 9500 hours.) Verify that the MAINTENANCE indicator turns off and remains off.



NOTE: The MAINTENANCE indicator will remain illuminated if the UV lamp has not been correctly plugged in or is not operating.

8. Turn power OFF and disconnect the 12V power module.
9. Replace the WCS 2.0 cover. Reinstall 6 screws at the rear of the cover, and reinstall the 2 screws at the bottom front of the cover. Hand-tighten to secure each screw.
10. Reconnect the 12V power module. Restart the WCS 2.0. Add water as necessary to the water bath.

Appendix B – User Guidelines and Troubleshooting

- Use only DI or distilled water in the acoustic bath.
- Daily water change is not required - the water is sterilized and filtered by the WCS 2.0.
- Check and top-off the water level prior to daily use, to make up for evaporation.
- Clean the degas pump lines and bath monthly with a bleach or equivalent solution to remove any hidden algae colonies – even with the WCS 2.0 operating, some colonies may take hold in tubing or crevices.
- Energy Saver option: When the ultrasonicator is not in use, place the CH05 in standby mode by pressing the “START/STOP” button (refer to CH05 manual for additional information). In standby, the pump continues to operate circulating the bath water through the WCS 2.0, but the cooling circuitry is not energized.

Problem	Possible Cause	Recommendation
Water is dripping onto the laboratory bench	Condensation from circulation of chilled water, leaks from a hose fitting	If conditioning chilled water, change to room temperature water to test if dripping stops. If not, open unit and visually check fittings
No operation, no power	No +12V supply to the <u>WCS 2.0</u>	Verify that power pack is plugged into AC wall power and connected to the 12V jack on the rear panel of the <u>WCS 2.0</u>
MAINTENANCE indicator is illuminated, and CHG lamp icon is blinking	More than 9500 hours have elapsed since last filter and UV lamp replacement	See Appendix A for filter and lamp replacement instructions
MAINTENANCE indicator is illuminated, no CHG lamp icon	UV lamp is not installed or is damaged.	See Appendix A for lamp replacement instructions

Appendix C – Bio-safety References

- Centers for Disease Control (CDC), Universal Precautions for Prevention of Transmission of HIV and Other Bloodborne Infections, published 1987, updated 1996
- Clinical and Laboratory Standards Institute (CLSI), GP17-A3 Clinical Laboratory Safety; Approved Guideline - Third Edition, published 2012, ISBN 1-56238-797-9
- Clinical and Laboratory Standards Institute (CLSI), M29-A4 Protection of Laboratory Workers from Occupationally Acquired Infections; Approved Guideline, Fourth Edition, published 2014, ISBN 1-56238-961-0
- Occupational Safety and Health Administration (OSHA), 29 CFR 1910.1030 Bloodborne Pathogens
- International Standards Organization (ISO) 15190:2003, Medical Laboratories – Requirements for Safety